

Item no:TR-217

90*90*200cm

Install Manual

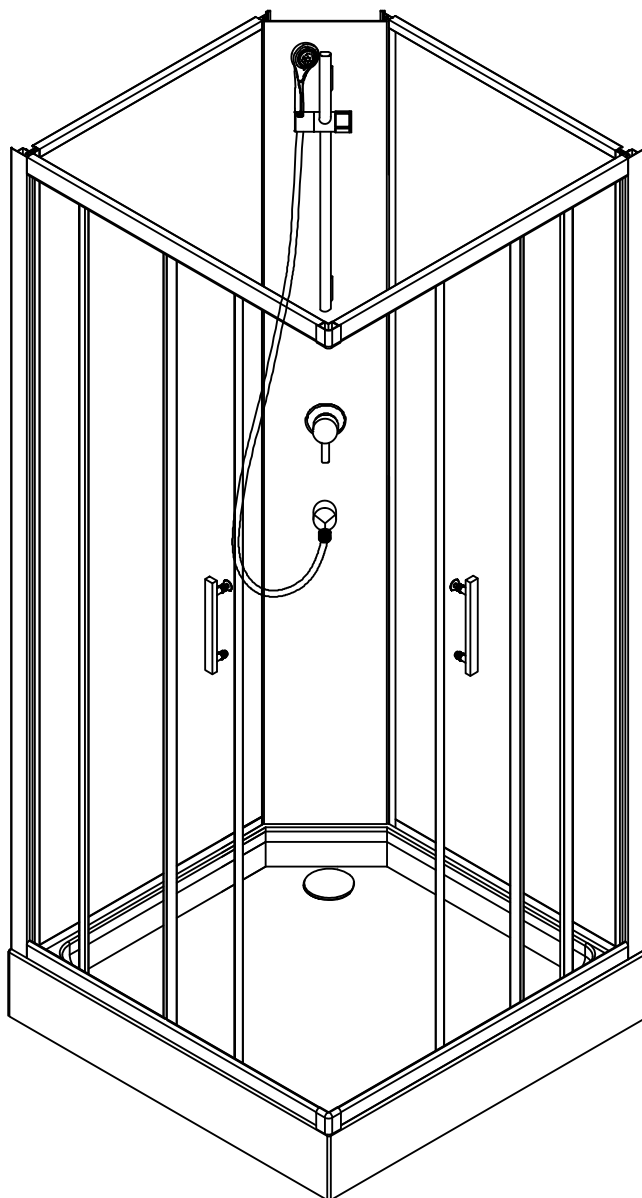

Viktig:

- 1. Minst to personer må montere dusjkabinettet**
- 2. Hjørnene på glasset er svært skjøre og må være beskyttet under installasjon**

WALK-IN

Assembling and using instructions



Don't use this shower enclosure without having reading this instruction manual

Safety advices :

Warning, glass is an extremely fragile material.

During handling always wear gloves.

For your safety, this product is made of tempered glass. This kind of glass is very resistant but also has the particularity to remember shock history.

By consequence, **it is important to handle this product with a maximum of precaution, by avoiding shock and torsion**, notably during setup.

Avoid to install this kind of product in an area which is particularly exposed to the shock.

Do not let children play with this product.

Do not stick adhesive film at the surface of the glass. In case of breaking, this may generate bigger splinters which could be dangerous.

Read carefully these instructions that will tell you important informations to set up and to use your shower enclosure. Be observant with these informations since they certify a correct set up and a correct using of this product. Furthermore, they will prevent the user or the installer from being hurt and from breaking any material. Store away this document in a safe place and in good condition.

Preparation

- After opening the packaging, read carefully these instructions, and then check all the delivering elements and check the shower enclosure in order to detect any carriage damage.
- If this glass is with silk screen printing, check that the smooth face will be inside the shower enclosure.
- Don't cling to this shower enclosure. This shower enclosure has not been designed to support heavy load.
- Note: The wall fixings included with this product are suitable for solid walls only. Plasterboard or stud walls may require specialist fixings (not supplied).
- Care should be taken when drilling into walls to avoid hidden pipes or electrical cables.
- Water supply flexible, tray and siphon are not provided.



Don't use any scrubbing products or any products made from ammoniac for cleaning this shower enclosure.

Produkt oversikt

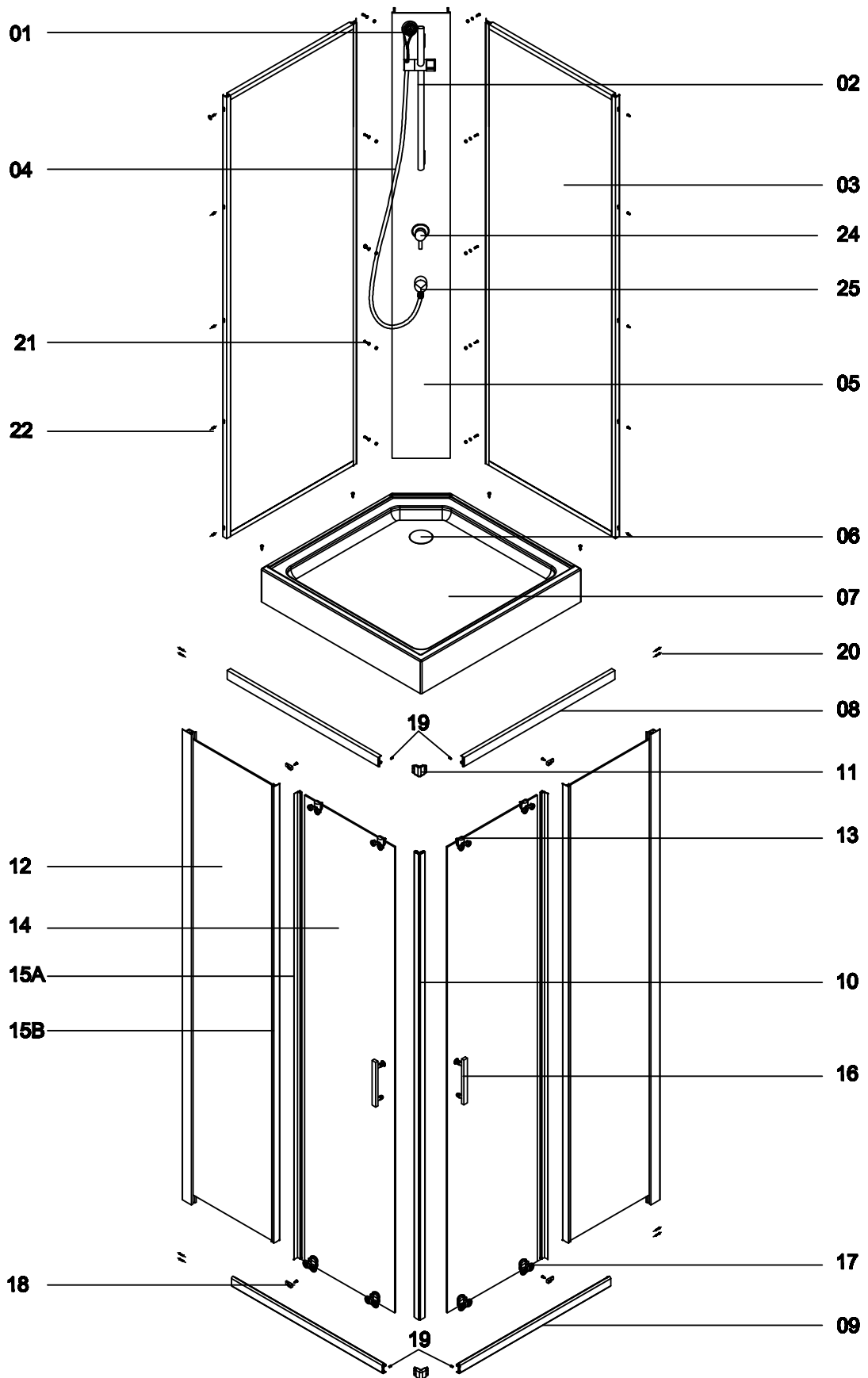

Tilbehør

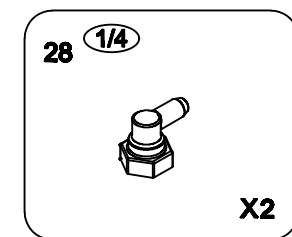
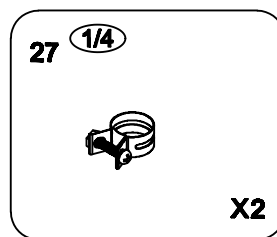
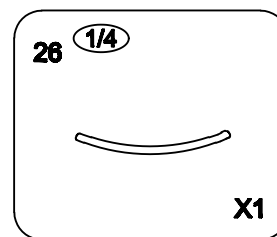
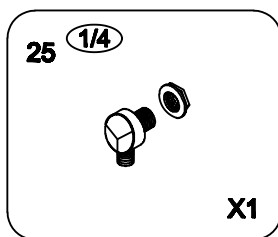
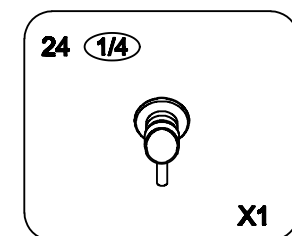
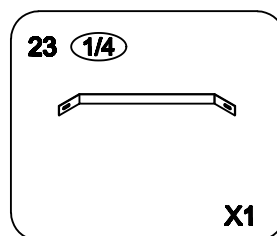
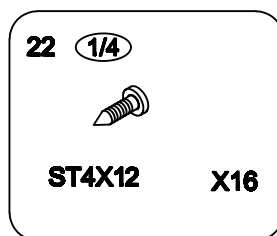
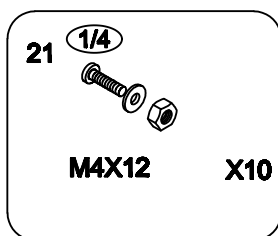
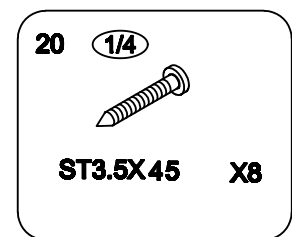
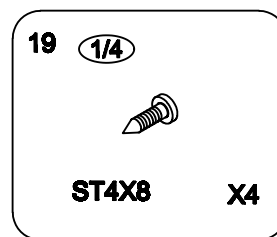
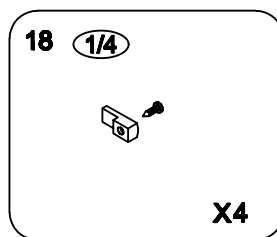
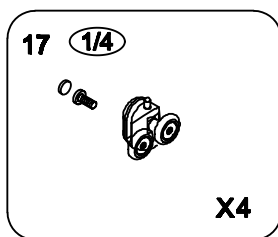
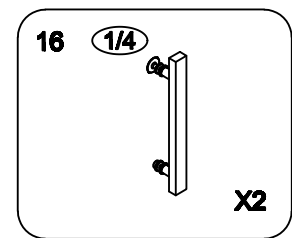
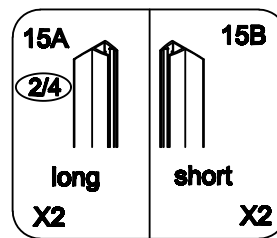
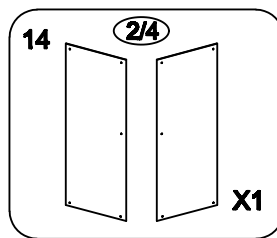
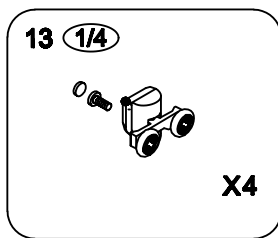
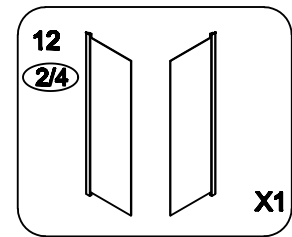
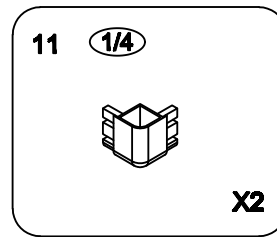
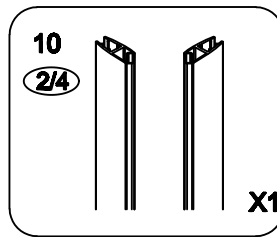
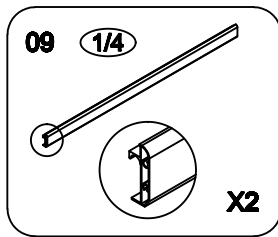
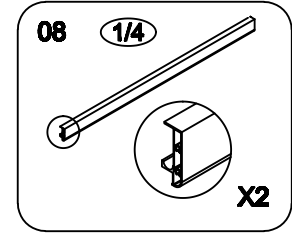
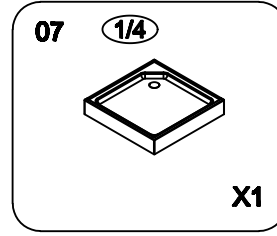
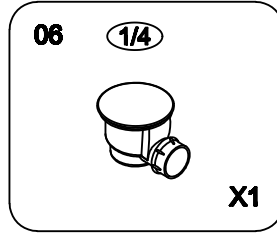
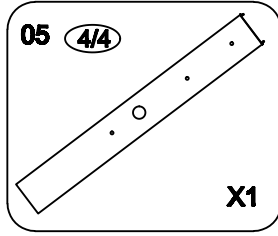
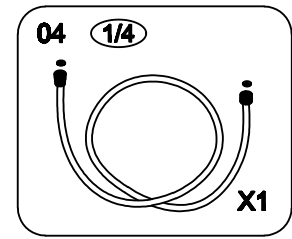
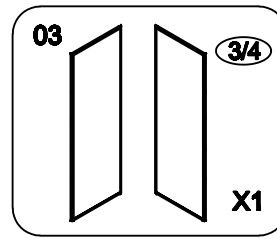
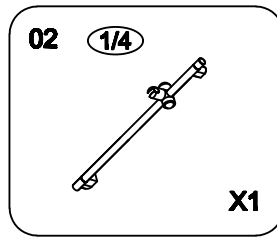
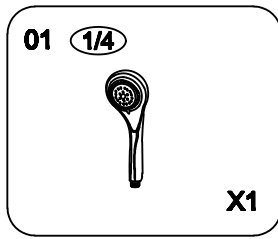

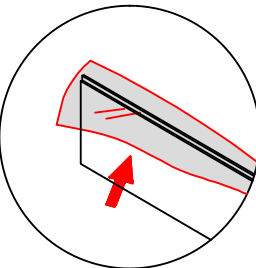
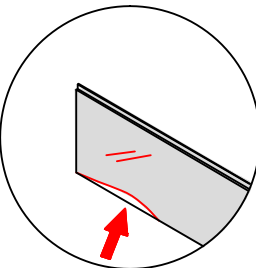
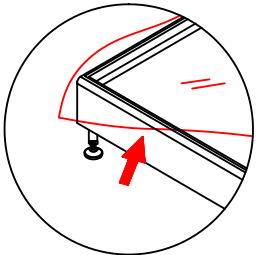
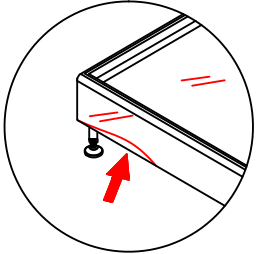
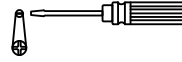
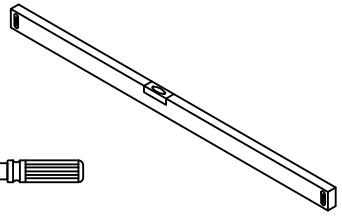
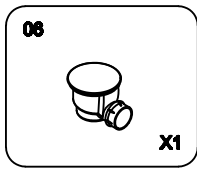
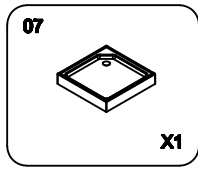

10

07

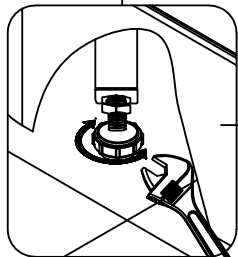

07

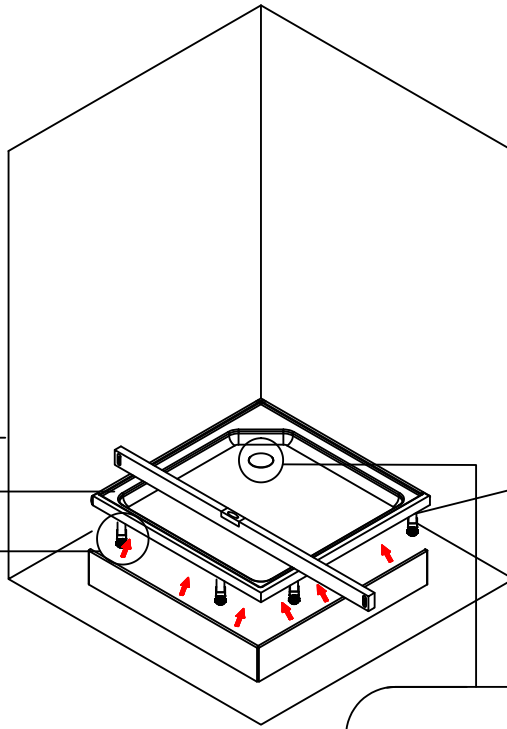

06

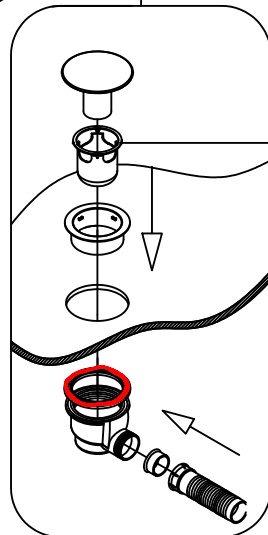

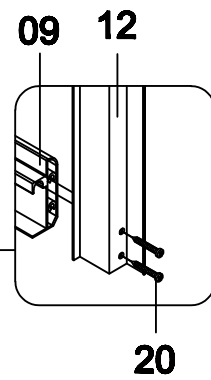
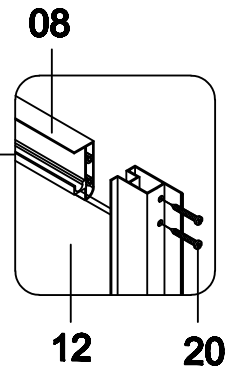
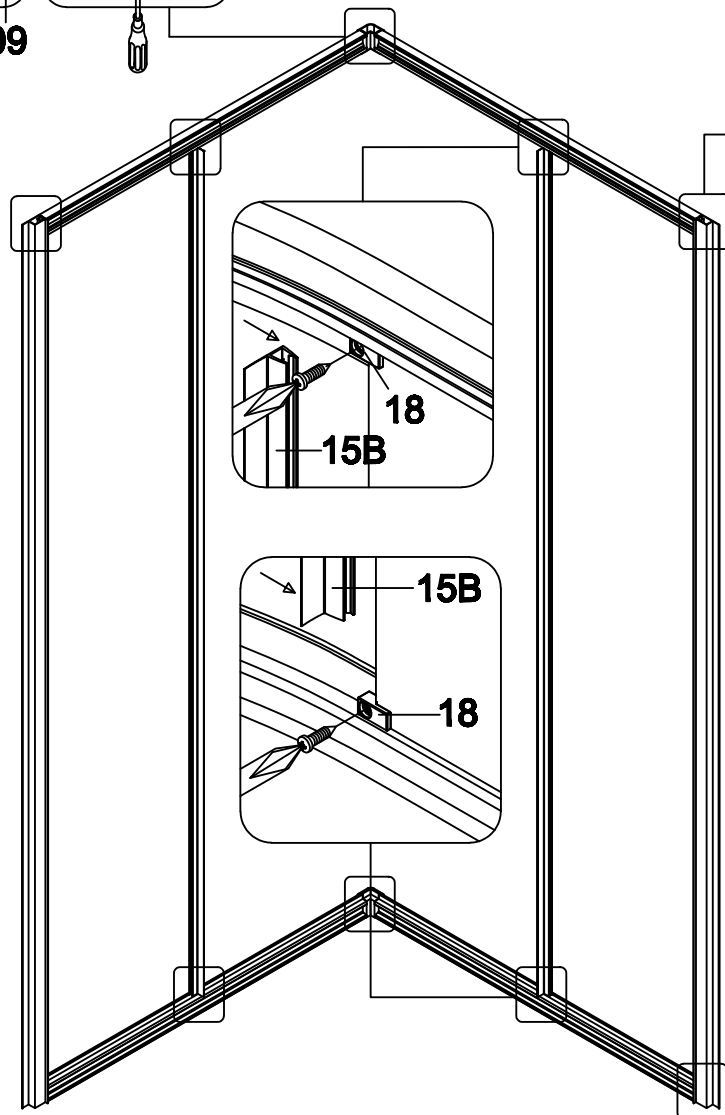
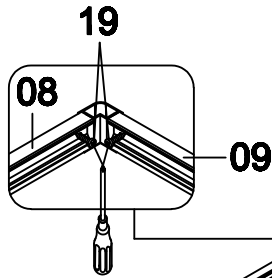
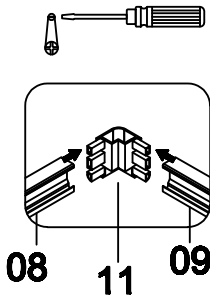
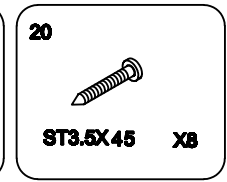
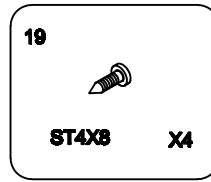
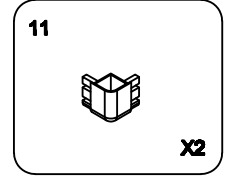
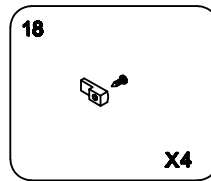
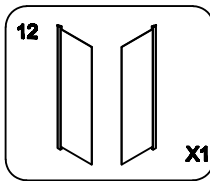
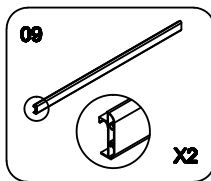
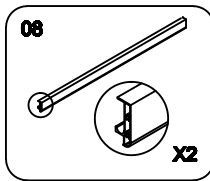

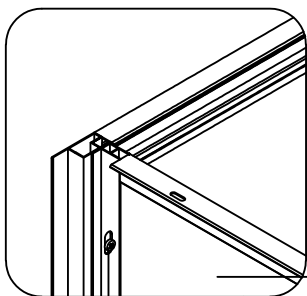
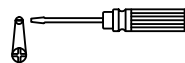
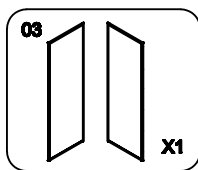
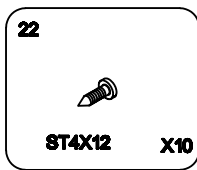

22

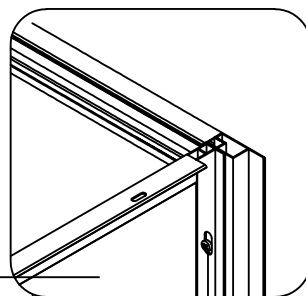

22

